



FIT

DAIKIN *FIT*

FLEXIBLE. INNOVATIVE. TECHNOLOGY.
QUIET / SPACE-SAVING / EFFICIENT
LOW PROFILE HEAT PUMP WITH
INVERTER (VARIABLE-SPEED) TECHNOLOGY



A young boy with dark hair is sitting on a circular white ledge, looking out a large window. He is holding a black cat with yellow eyes. The window shows a snowy winter scene with trees and a building. The boy is wearing a grey t-shirt and dark pants. The overall mood is peaceful and cozy.

Today, the air is perfect. Perfect temperature. Perfect humidity. Perfectly clean and fresh, like just after a rainstorm. And the only thing more perfect than this outdoor scenario is that it's all happening inside. Because that's where we work. That's where we play, where we sleep, where we truly live.

And that's why at Daikin, we aim to make the air inside as refreshing as the outside. Better comfort. Better control and efficiency. Better quality. So you can create your own unique ecosystem. And everyday is perfect.

Inside and out.

DESIGNED TO FIT COMFORT, SPACE-SAVING, AND EFFICIENCY REQUIREMENTS WITH EASE.

The Daikin *Fit* system is a side discharge, smart HVAC system that won't compromise on comfort and connects to ducted solutions traditional to the unitary market. In a market saturated with expensive high-tiered inverters, the system provides a premium mid-efficiency inverter at an affordable rate. The low profile of the outdoor unit offers solutions when a traditional cube style cannot.

AFFORDABLE. EFFICIENT. SPACE-SAVING.

When installation space is limited, families shouldn't need to compromise on comfort. Ideal for zero lot lines, roof, wall, or terrace areas, the Daikin *Fit* features a new style solution allowing you to meet the demands of homes with the strictest of limitations with relative ease.



TRADITIONAL (CUBE STYLE) OUTDOOR UNIT

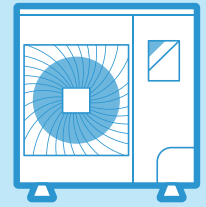

NEW DAIKIN *FIT* SIDE DISCHARGE SOLUTION



FEATURES AND BENEFITS

- » Up to **18 SEER** and **10 HSPF**
- » **Compact** – The trunk style outdoor unit is perfect when installation space is limited
- » **Inverter (variable-speed) Compressor** – Ideal indoor comfort and efficiency
- » **Low dBa** – Reclaim outdoor space
- » **Quiet-mode** – Provides enhanced acoustical comfort
- » **Blue Fin Coat** – Long condenser coil life and reliability
- » **Swing Compressor** – Quiet and dependable
- » **Side panel access** – Ease of service
- » **Lightweight** – Easier to handle and install (compared to traditional cube style systems)
- » **Intelligent Defrost Mode** – The outdoor unit will enable this mode to help prevent frost/ice from building up in cold climate conditions. It will also help with longer heating operation time for additional comfort for occupants (compared to HVAC systems without this function).
 - A selectable defrost backup heat option, when turned off, will lower power consumption during defrost.
- » **Advanced water-shedding drain pan** – Engineered with multiple drain holes and channels to help provide effective water shedding.
- » **Hot start technology** – When the heating operation starts or when the unit changes from cooling to heating there is no cold draft released into the room.



THE DAIKIN *FIT* IS BACKED BY A 12-YEAR PARTS LIMITED WARRANTY* AND A 12-YEAR UNIT REPLACEMENT LIMITED WARRANTY*

* Complete warranty details available from your local dealer/contractor or at www.daikincomfort.com. To receive the 12-Year Unit Replacement Limited Warranty and 12-Year Parts Limited Warranty, online registration must be completed within 60 days of installation. Additional requirements for annual maintenance are required for the Unit Replacement Limited Warranty. Online registration and some of the additional requirements are not required in California or Québec.

INTRODUCING DAIKIN *FIT* HEAT PUMP



DAIKIN *FIT* OUTDOOR UNIT — DZ17VSA

1 Variable-Speed DC Fan.
High efficiency and low sound levels.

2 Blue Fin Corrosion Coating.
1000 hours salt spray rated as standard. Hydrophilic coating to help keep the coil clean.

3 7mm Coil.
High heat exchanger efficiency and compact casing design.

4 Inverter Board Cooled by Refrigerant Circuit¹.
Elimination of condenser fan pressure drop caused by heat sink used on previous generations.

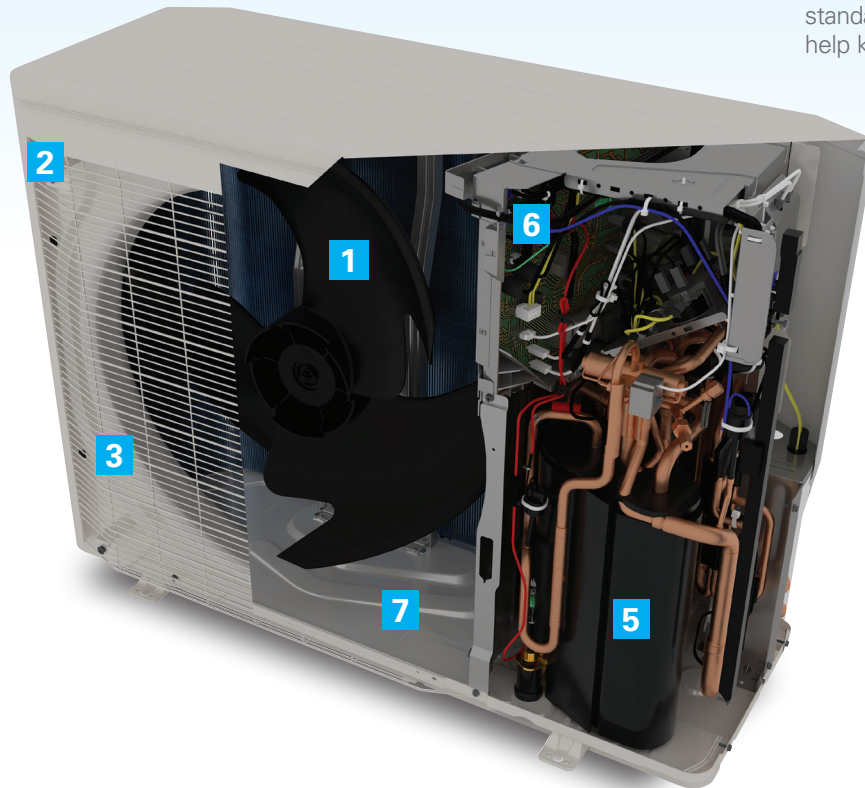

5 Daikin Swing Compressor.
High efficiency. Low sound levels.

6 Intelligent Defrost Mode.
The outdoor unit will enable this mode to help prevent frost/ice from building up in cold climate conditions. It will also help with longer heating operation time for additional comfort for occupants (compared to HVAC systems without this function).
- A selectable defrost backup heat option, when turned off, will lower power consumption during defrost.

7 Advanced water-shedding drain pan.
Engineered with multiple drain holes and channels providing effective water shedding.

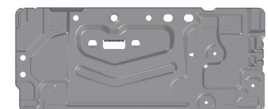

VISIT THE DAIKIN *FIT* MICROSITE
TO LEARN MORE:
www.daikincomfort.com/go/fit/



¹Model specific, refer to product engineering manual for details.

DAIKIN INVERTER TECHNOLOGY

Wouldn't it be great if your cooling and heating system weren't an energy hog? Daikin inverter technology helps systems run at an energy-conserving level, despite the climate conditions, by making slight adjustments to the compressor's speed. Daikin systems will reach the desired temperature faster and maintain a more constant temperature compared to traditional ON/OFF systems. It will not frequently start and stop the "old fashioned way" just as a car is more efficient and comfortable traveling on a highway than it is in stop-and-go city traffic.

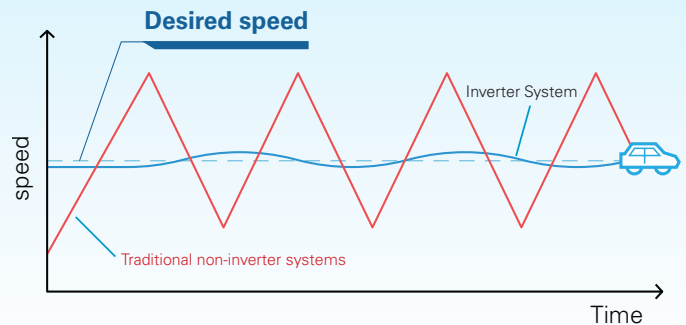

LEARN MORE ABOUT THE BENEFITS OF INVERTER TECHNOLOGY:

www.daikincomfort.com/go/inverter/



PROPRIETARY SWING COMPRESSOR

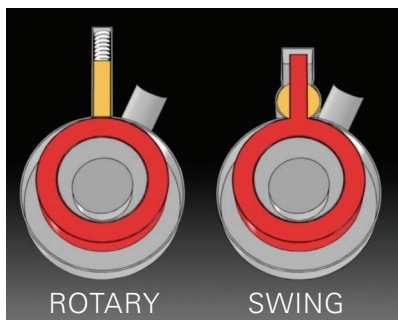

Daikin *Fit* systems are engineered with Daikin swing compressor technology. This technology brings additional peace of mind to every homeowner. The main parts are integrated into one main component minimizing wear and tear on the system. This enhanced functionality is designed to help eliminate refrigerant leaks from high side to low side and is an ideal compressor choice for high (under 65,000 Btu/h) efficiency systems, such as the Daikin *Fit*.

VARIABLE-SPEED DC FAN

Our Daikin variable-speed DC fan motor operates with PWM (Pulse Width Modulation). With PWM, the Daikin *Fit* operates using adequate energy based on load requirements, providing enhanced operational efficiency (compared to systems without PWM). The image to the right is an example of what PWM power pulses look like (may differ depending on system, and load requirements).

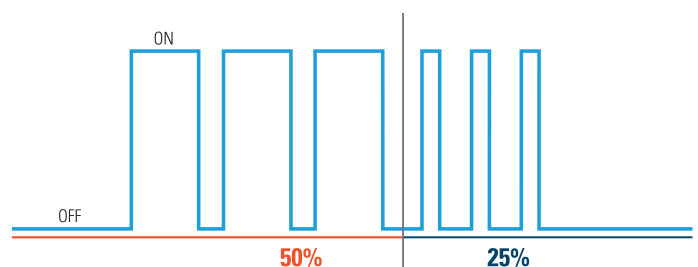

PWM (Pulse Width Modulation) as used in the DC fan motor

WHY DAIKIN *FIT*?

DAIKIN BLUE FIN CORROSION COATING

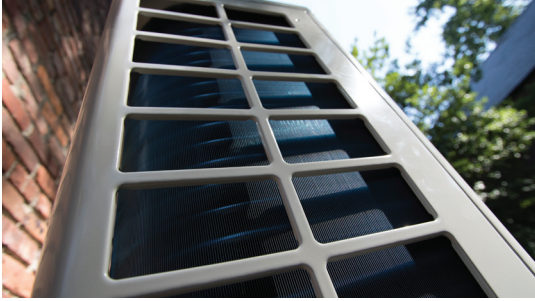

Daikin *Fit* systems feature our professional engineered hydrophilic Blue Fin coating (1000+ hours salt spray rated) as standard. The Blue Fin corrosion coating protects the outdoor unit against weather conditions and reduces friction to allow water to drain quicker from the coil and washes the coil clean.

FLEXIBLE PIPING CAPABILITIES

The Daikin *Fit* system is a great choice for most single, two, and three-story homes with existing ductwork. The ability to utilize existing line sets, and connect up to 100' of pipe, for typical installations, (braze connections – no flare) can offer new solutions to overcome project obstacles.

CONNECTING PIPING (maximum)						
1.5 - 5 ton						
Length			Height			
100 ft			90 ft			
PIPING DIAMETER						
COND UNIT TONS	RECOMMENDED LINE SET DIAMETER					
	Liquid			Gas		
	1/4"	3/8"	5/8"	3/4"	7/8"	1 1/8"
1.5 ton	A	S	A	S		
2 ton		S	A	S		
2.5-3 ton		S		A	S	
3.5-5 ton		S			A	S
A = ALLOWABLE / S = STANDARD						

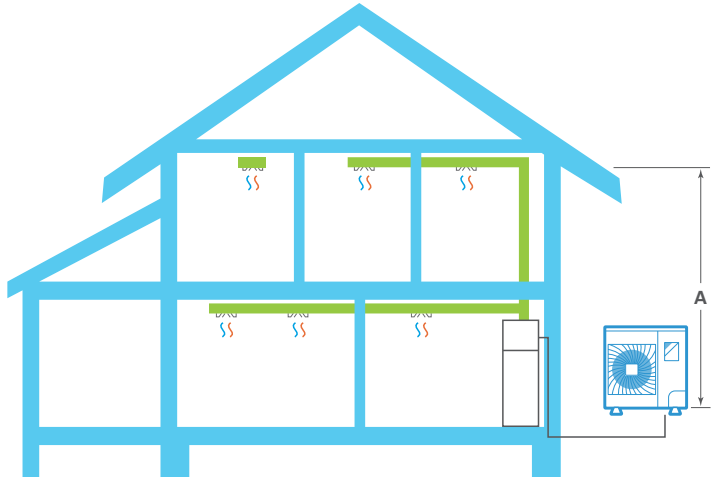

5000

DESIGNED TO FIT:

- ▶ APPLICATION
- ▶ BUDGET
- ▶ COMFORT
- ▶ DESIGN

LEARN HOW MUCH YOU
COULD SAVE WITH AN
INVERTER SYSTEM.
VISIT THE DAIKIN
EFFICIENCY ADVISOR:



www.daikincomfort.com/go/energyadvisor/

Application

A NEW SOLUTION FOR EVEN THE MOST UNIQUE PROJECTS:

- » Mid-efficiency heat pumps can be applied across North America
- » Perfect alternative to the traditional cube style unitary products in a 1:1 application
- » Traditional homes, townhomes, bungalows, condos, zero lot line homes, patios, terrace, and multi-story locations that would typically require a crane
- » Install using existing ductwork and existing line sets
- » Space-saving low profile trunk style outdoor unit for easy carrying and installation in tight spaces
- » Ease of service and maintenance with a quick-to-access side panel
- » New DVFEC Air Handler with 7 mm evaporator coils
- » Utilize EEV coil family: CAPEA (Upflow/Downflow) with 7mm evaporator coils
- » Connects with any Daikin communicating gas furnace 80% and 90%+ for dual fuel capability
- » Compatible with Daikin *One+* smart thermostat and other Daikin communicating equipment
- » For additional IAQ (Indoor Air Quality) control, add Daikin *One* ecosystem and CleanComfort® solutions

DAIKIN FIT HEAT PUMP

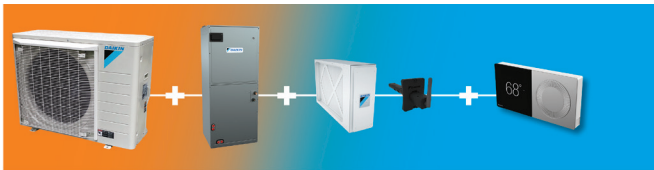

DAIKIN FIT HEAT PUMP WITH DUAL FUEL

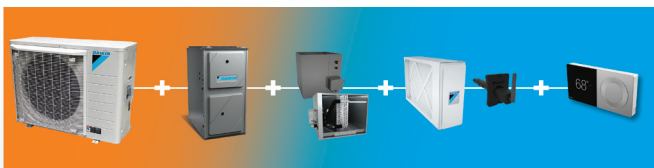

AT TIME OF LAUNCH, PARTIAL OFFERING AVAILABLE:
1.5 TO 3.0 TONS WITH UPFLOW/DOWNFLOW COILS

Budget

OPERATIONAL EFFICIENCIES THAT DRIVE SAVINGS:

The inverter compressor is the heart of a Daikin *Fit* system. Daikin's inverter technology is responsible for delivering intelligent comfort with efficiency, based on demand. The inverter (variable-speed) compressor delivers the capacity required to maintain desired room conditions, typically reducing energy consumption by up to 30% or more (compared to traditional fixed-speed systems).

- » **Intelligent Defrost Mode:** The outdoor unit will enable this mode to help prevent frost/ice from building up in cold climate conditions. It will also help with longer heating operation time for additional comfort for occupants (compared to HVAC systems without this function).
 - A selectable defrost backup heat option, when turned off, will lower power consumption during defrost.
- » The enhanced functionality of the variable-speed DC fan motor can offer an increase of approximately 20% in efficiency (compared to systems with a conventional AC motor).

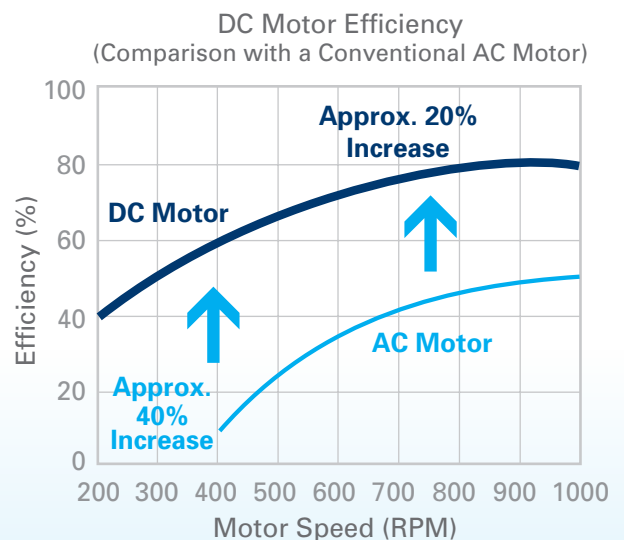

Note: Data is based on studies conducted under controlled conditions at a Daikin laboratory.

Comfort

IDEAL TEMPERATURE AND LOW SOUND LEVELS:

Traditional (non-inverter) systems offer basic ON/OFF operation mode only. With the compressor turning ON/OFF constantly, the system works to reach set indoor temperature. With inverter technology, the Daikin *Fit* system, can adjust operations to meet the desired comfort levels.

- » **Hot Start Technology:** When the heating operation starts or when the unit changes from cooling to heating there is no cold draft released into the room.

Undesirable operational sounds often accompany non-inverter (traditional) HVAC systems. These continuous sounds can become a nuisance in yards, or when the system is installed near a window. With the ability to reach sound power levels as low as 56dB(A), the Daikin *Fit* system can help bring additional acoustical comfort to any environment (inside and out).

SOUND LEVELS AS LOW AS:

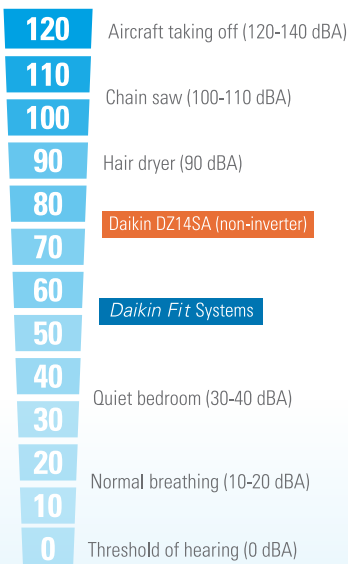

Design

COMPACT FOOTPRINT TO MEET DESIGN DEMANDS:

Feature rich design in a compact footprint that includes:

- » **Blue Fin Coat:** Long condenser coil life and reliability
- » **Swing Compressor:** Quiet and dependable
- » **Advanced Water-Shedding Drain Pan:** Engineered with multiple drain holes and channels to help provide effective water shedding.

With clearance space as little as 4" from a wall and compact size, the Daikin *Fit* system works when installation space is limited.

- » Fit more in your HVAC tech van or truck; 4 – 5 Daikin *Fit* units as opposed to 1 or 2 traditional systems
- » Easy to bring to the installation site and install on pad — the single fan unit can be transported by a single worker or on a dolly

UNIT DIMENSIONS

1.5-3 TON	3.5-5 TON
W: 36.6" x D: 13.8" x H: 27.4"	W: 37" x D: 12.6" x H: 39"

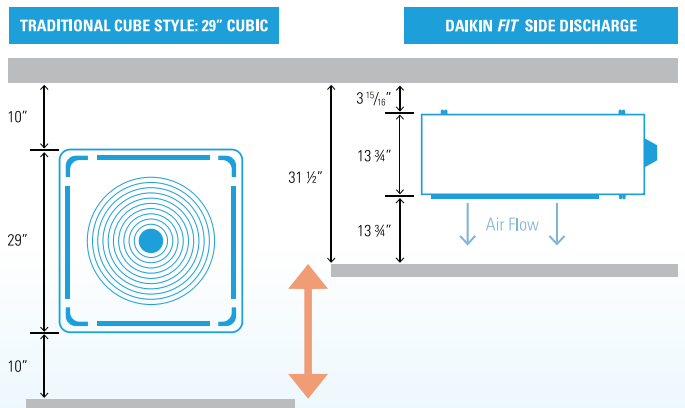



NEW DVFEC MULTI-POSITION, VARIABLE-SPEED, ECM-BASED AIR HANDLER

- » **Multi-position AHU:** Upflow/downflow, and horizontal left/right orientations.
- » **7mm All Aluminum Evaporator Coil:**
 - Enhance indoor comfort.
 - Outstanding heat transfer properties
 - Improve refrigerant balance between Indoor and Outdoor unit.
- » **Variable-speed Electrically Commutated Motor (ECM):**
 - Provides gradual startup and shutdown for unobtrusive operation with lower energy consumption.
 - Constant low-speed operation for outstanding filtration and comfort levels.
- » **Electronic Expansion Valve:**
 - Better utilization of Evaporator.
 - Wide operation range.
- » **Communicating:** Compatible with Daikin *One+* smart thermostat and other communicating equipment.



BACKED BY A
12-YEAR PARTS
LIMITED WARRANTY*

*Complete warranty details available from your local dealer/contractor or at www.daikincomfort.com. To receive the 12-Year Parts Limited Warranty, online registration must be completed within 60 days of installation. Online registration is not required in California or Québec.



80-97% AFUE COMMUNICATING GAS FURNACE

- » **Durable heat exchanger:** Unique tubular stainless-steel construction formed using wrinkle-bend technology results in an extremely durable heat exchanger. Paired with a stainless-steel secondary heat exchanger, this combination provides for reliability, durability and efficiency.
- » **Modulating gas valve:** Operates between 35% - 100% capacity, providing precise efficiency and the ultimate in comfort.
- » **Continuous air circulation:** Provides filtration and keeps air moving throughout your home to help maintain comfort.
- » **Self-diagnostic control board:** Continuously monitors the system for consistent, reliable operation.
- » **Quiet, variable-speed induced draft blower:** Provides precise control and enhanced energy-efficient performance as compared to single-speed blowers.

LEARN MORE AT: www.daikincomfort.com/products/heating-cooling/whole-house/air-handlers-coils

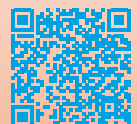



CAPEA – ALL ALUMINUM COILS

- » Available in 1.5-Ton through 3-Ton capacities
- » Engineered for compatibility with Daikin *Fit* outdoor units
- » Electronic Expansion Valve (EEV) models feature
 - Communicating (Compatible with the Daikin One+ smart thermostat and other Daikin communicating equipment)
 - Cooling and heat pump applications
 - Fault recall of six most recent faults
 - PID control loop for precision capacity control
- » Seamless integration to full suite of Daikin controls using communicating control board
- » Light weight all aluminum evaporator coil
- » Air cleaner and humidifier integration capable (rules apply, refer to installation manual for details).
- » Foil-faced insulation covers internal casing to reduce cabinet condensation
- » Ships factory standard upflow with easy field conversion to downflow
- » UV and rust resistant, 5VA rated thermoplastic drain pan with integrated secondary drain



BACKED BY A
12-YEAR PARTS
LIMITED WARRANTY*

*Complete warranty details available from your local dealer/contractor or at www.daikincomfort.com. To receive the 12-Year Parts Limited Warranty, online registration must be completed within 60 days of installation. Online registration is not required in California or Québec.



MBVC – MULTI-POSITION AIR HANDLER

- » Communicating (Compatible with the Daikin *One+* smart thermostat and other Daikin communicating equipment)
- » Variable-speed ECM indoor blower motor
- » Provides constant CFM over a wide range of static pressure conditions independent of duct system
- » CFM indicator
- » Fault recall of six most recent faults
- » Built-in dehumidification feature
- » Blower section usable as an electric furnace
- » 21 inch deep cabinet for easier attic access
- » Control board includes a blower time-delay in the cooling mode
- » Foil-faced insulation lines the cabinet to help reduce operating sound and cabinet condensation
- » Horizontal or vertical configuration



BACKED BY A
12-YEAR PARTS
LIMITED WARRANTY*

*Complete warranty details available from your local dealer/contractor or at www.daikincomfort.com. To receive the 12-Year Parts Limited Warranty, online registration must be completed within 60 days of installation. Online registration is not required in California or Québec.

ENHANCE YOUR ECOSYSTEM WITH OUR ARRAY OF INDOOR AIR QUALITY SOLUTIONS

DAIKIN PREMIUM AIR CLEANER



- » The new Daikin premium air cleaner is a MERV 15 media filter that removes more than 85% of particles down to 0.3 microns*
 - » Pleated media filter removes over 98% of *Aspergillus fumigatus*, *Aspergillus versicolor*, and *Stachybotrys chartarum* from the airstream*
 - » Pleated media filter removes over 99% of Ragweed, over 72% of Cat Dander, and over 73% of Dust Mites from the airstream*
 - » Extra deep, 5¼" pleated filter constructed of cellulose-free, hydrophobic polyolefin fibers
 - » Filter should be changed once or twice a year based on conditions within the home
- * Testing performed by LMS Technologies, Inc.

DAIKIN ONE HOME AIR MONITOR

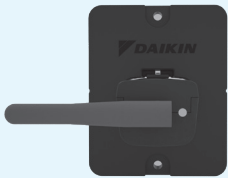

Detect:

- » The Daikin *One* home air monitor will monitor and learn baseline air quality in the home, over 7 days, then provide a rolling 7-day average baseline.
- » When potential particulate and/or chemical events occur outside of this average baseline, the system will detect the potential deviation and send alerts to the Daikin *One+* smart thermostat.

Visualize:

- » From the Daikin *One+* smart thermostat, visualize the estimated air quality in real-time directly on the thermostat or through the smartphone app.
- » Indoor Air Quality Event Monitor – from this option, see when particles or chemicals are elevated compared to the 7-day baseline to

help to understand and control your air. The readings will include:

- **Green** - typical concentrations in the home
- **Yellow** - elevated concentrations in the home
- **Orange** - very elevated concentrations in the home

Act:

- » With built-in *Air Intelligence*, the Daikin *One* home air monitor and Daikin *One* ecosystem provide adaptive solutions homeowners advance through their Daikin *One+* smart thermostat based on air quality alerts.
 - Turn on the furnace or air handler to increase filtration through the high-efficiency Daikin premium air cleaner to address particles.
 - Turn on exhaust/ventilation or open a window to help reduce detected chemicals within the home.

CLEAN COMFORT® INDOOR AIR ESSENTIALS

Clean Comfort indoor air essentials include:

- » FILTRATION
- » PURIFICATION
- » HUMIDITY CONTROL
- » VENTILATION

FILTRATION
PRODUCTS



PURIFICATION
PRODUCTS

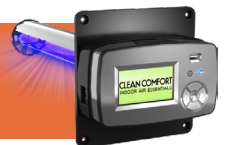

VENTILATION
PRODUCTS



HUMIDITY
CONTROL
PRODUCTS





The Daikin *One* + smart thermostat is an intelligent home air controller from the world's leading heating, ventilating, and air conditioning (HVAC) manufacturer. It is a cloud-connected hub of sophistication, integrated for controlling temperature, humidity, and air quality.

1 **The high-resolution color touch screen display** is protected by the same toughened glass used in smart phones.



A number of screen savers are available, including this analog clock.

2 **The anodized aluminum bezel and dial** are precision manufactured. The surfaces have a fine bead blast with a warm hued anodized finish. The dial rotation is extraordinarily smooth because it rests on a bearing assembly typically found in precision instruments. A switch behind the dial enables users to return to the home screen from any menu with a single tap.



Turning the dial changes the temperature set-point.

3 **An integrated WiFi radio** connects to the internet (via a home router) to the cloud and on to the homeowner mobile application. The Daikin cloud will also seamlessly integrate with open smart home architectures, including *Amazon Alexa* and *Google Assistant*, enabling consumers to effortlessly use features such as voice control.

4 **A thin LED light bar** sits flush within the bottom surface and runs from edge to edge, delicately illuminating the wall beneath. Emitting a soft emotive glow, the light bar indicates the current system mode: red-orange for heating, blue for cooling.



5 **Built-in bubble level** aids professional installation.

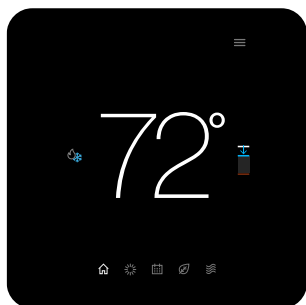

The **home screen** displays the current temperature, the current system mode, and icons leading to each of the top level screens.

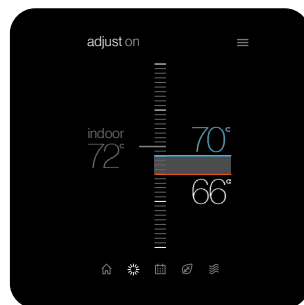

The **adjust screen** displays the current temperature on the left and set-points on the right. Change the set-points by dragging them or by turning the dial.

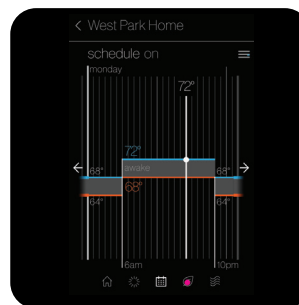

The **schedule screen** displays upcoming set-point changes and scheduled times. It also offers access to edit mode, where you can adjust the schedule.

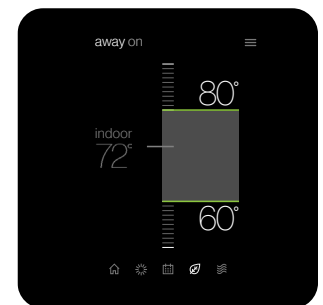

The **away screen** displays energy saving set-points. Energy saving can be invoked manually or automatically when the mobile app recognizes everyone is away.

DAIKIN FIT - HEAT PUMP OUTDOOR UNIT

Model Name	DZ17VSA 181A*	DZ17VSA 241A*	DZ17VSA 301A*	DZ17VSA 361A*	DZ17VSA 421A*	DZ17VSA 481A*	DZ17VSA 601A*
Capacities and Ratings¹							
Max. Cooling (BTU/h)	17,100	22,800	28,400	34,200	40,000	45,500	54,000
Max. Heating (BTU/h)	17,100	22,800	28,400	34,200	40,000	45,500	54,000
Ambient Operation Range	0 to 115 (-17.8 to 46.1) ²						
Cooling (°FDB(°CDB))	-20 to 70 (-29.9 to 21.1) ²						
Heating (°FDB(°CDB))							
Compressor							
Type	Swing Compressor	Swing Compressor	Swing Compressor	Swing Compressor	Swing Compressor	Swing Compressor	Swing Compressor
RLA	10.5	15.2	20.0	20.0	27.0	27.0	29.0
Condenser Fan Motor							
Horsepower (HP)	3/16	3/16	3/16	3/16	1/4	1/4	1/4
FLA	2.18	2.18	2.70	2.70	2.50	2.50	2.50
Refrigeration System							
Refrigerant Line Size							
Liquid Line Size ("O.D.)	3/8"	3/8"	3/8"	3/8"	3/8"	3/8"	3/8"
Suction Line Size ("O.D.)	3/4"	3/4"	7/8"	7/8"	1 1/8"	1 1/8"	1 1/8"
Refrigerant Connection Size							
Liquid Valve Size ("O.D.)	3/8"	3/8"	3/8"	3/8"	3/8"	3/8"	3/8"
Suction Valve Size ("O.D.)	3/4"	3/4"	7/8"	7/8"	7/8"	7/8"	7/8"
Valve Connection Type	Front Sealing	Front Sealing	Front Sealing	Front Sealing	Front and Back Sealing	Front and Back Sealing	Front and Back Sealing
Refrigerant Charge (oz.)	81	81	88	88	118	118	127
Expansion Device	EEV	EEV	EEV	EEV	EEV	EEV	EEV
Superheat at Service Valve	Auto-control	Auto-control	Auto-control	Auto-control	Auto-control	Auto-control	Auto-control
Subcooling at Service Valve	10±1°F	12±1°F	14±1°F	14±1°F	10±1°F	8±1°F	9±1°F
Electrical Data							
Voltage-Phase (60 Hz)	208/230-1	208/230-1	208/230-1	208/230-1	208/230-1	208/230-1	208/230-1
Minimum Circuit Ampacity ⁴	12.7	17.4	22.7	22.7	34.5	34.5	36.5
Max. Overcurrent Protection ⁵	15	20	25	25	35	35	40
Min / Max Volts	197/253	197/253	197/253	197/253	197/253	197/253	197/253
Electrical Conduit Size	1/2"	1/2"	1/2"	1/2"	1/2" or 3/4"	1/2" or 3/4"	1/2" or 3/4"
Equipment Weight (lbs)	116	116	125	131	170	170	183
Ship Weight (lbs)	135	135	143	150	185	185	198

** Inverter/Controller limited to less than 1 Amp

¹ Tested and rated in accordance with AHRI Standard 210/240.

² Line set length should be <=50 ft if normal cooling mode ambient temperature is below 14°F (applies to select sizes, see Installation Instructions for details).

³ Line set length >= 30 ft will have heating operation lockout at 15°F.

⁴ Wire size should be determined in accordance with National Electrical Codes; extensive wire runs will require larger wire sizes.

⁵ Must use time-delay fuses or HACR-type circuit breakers of the same size as noted.

Notes: Always check the S&R plate for electrical data on the unit being installed. / System charge must be adjusted per Installation Instructions Final Charge Procedure.

DVFC

Model	Dimensions			Nominal Tons	Connection Size		Ship Weight (lbs)
	W"	D"	H"		Liquid"	Suction"	
DV24FECB14	17 1/2	21	45	1 1/2 - 2	3/8"	3/4"	115
DV36FECC14	21	21	53 3/16	2.5 - 3	3/8"	7/8"	140
DV42FECC14	21	21	53 3/16	3.5	3/8"	7/8"	140
DV48FECD14	24 1/2	21	53 3/16	3.5 - 4	3/8"	7/8"	150
DV60FECD14	24 1/2	21	58	3.5 - 5	3/8"	7/8"	167

The manufacturing entity reserves the right to discontinue, or change at any time, specifications or designs without notice or without incurring obligations.

CAPEA

Model	Dimensions			Nominal Cooling Tons	Connection Size		Ship Weight (lbs)
	W"	D"	H"		Liquid"	Suction"	
CAPEA1818B4	17 1/2	21	18	1 1/2	3/8"	3/4"	43
CAPEA1818C4	21	21	18	1 1/2	3/8"	3/4"	45
CAPEA2422B4	17 1/2	21	22	2	3/8"	3/4"	48
CAPEA2422C4	21	21	22	2	3/8"	3/4"	51
CAPEA3026B4	17 1/2	21	26	2 1/2	3/8"	7/8"	54
CAPEA3026C4	21	21	26	2 1/2	3/8"	7/8"	57
CAPEA3026D4	24 1/2	21	26	2 1/2	3/8"	7/8"	62

The manufacturing entity reserves the right to discontinue, or change at any time, specifications or designs without notice or without incurring obligations.

SUPPORT AND PEACE OF MIND

DID YOU KNOW YOU MAY BE ABLE TO TAKE ADVANTAGE OF STATE AND LOCAL REBATES?

Visit www.daikincomfort.com/rebates
to see if you are eligible!



TAKE COMFORT IN OUR FINANCING OPTIONS

Financing for your Daikin home comfort system is available via EGIA.

For more details and enrollment information,
visit www.egia.org/daikin or call **888-691-0387**.



Add further peace of mind with our comprehensive options for extended service plans.

AsureSM EXTENDED SERVICE PLAN

Daikin understands that you expect to enjoy years of uninterrupted service from your home comfort system. By including an AsureSM Extended Service Plan you can have peace of mind knowing that in the event of an equipment failure, Daikin will pick up the cost of the repair. For only pennies a day, you can be protected from the unplanned cost of a service call and from the increasing cost of service over the life of your equipment.

- » No unexpected repair bills
- » Prompt service provided by an authorized AsureSM Dealer
- » All repairs performed with Daikin authorized replacement parts
- » No pre-authorization required
- » No out-of-pocket deductible

These benefits mean that you can count on staying cool in the summer and warm in the winter — an AFFORDABLE benefit that adds VALUE over the life of your home comfort product.

Contact your local Daikin sales representative or local contractor for more information on current extended service plans that are available to you.





WARNINGS:

- » Always use a licensed installer or contractor to install this product. Do not try to install the product yourself. Improper installation can result in water or refrigerant leakage, electrical shock, fire or explosion.
- » Use only those parts and accessories supplied or specified by Daikin. Ask a licensed contractor to install those parts and accessories. Use of unauthorized parts and accessories or improper installation of parts and accessories can result in water or refrigerant leakage, electrical shock, fire or explosion.
- » Read the User's Manual carefully before using this product. The User's Manual provides important safety instructions and warnings. Be sure to follow these instructions and warnings.
- » For any inquiries, contact your local Daikin sales office.

Amazon, Alexa and all related logos are trademarks of Amazon.com, Inc. or its affiliates.

Google, GoogleAssistant, and all related logos are trademarks of Google LLC or its affiliates.

ADDITIONAL INFORMATION

Before purchasing this appliance, read important information about its estimated annual energy consumption, yearly operating cost, or energy efficiency rating that is available from your retailer.

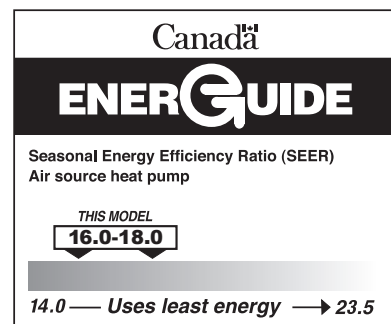

Our continuing commitment to quality products may mean a change in specifications without notice.
© 2020 **DAIKIN NORTH AMERICA LLC** · Houston, Texas · USA · www.daikincomfort.com or www.daikinac.com

CB-FITHP 04-20